

Accessories: Mounting unit BMS CU-P-D12-AD08-00

Common Data

Version

Sensor holder for 1 rod $\varnothing 12$ mm
or 10x10 mm

Usable with

for cylindrical sensors M8

Mechanical Data

Measurements WxHxD or Dia x D

60x30x30

Material

POM

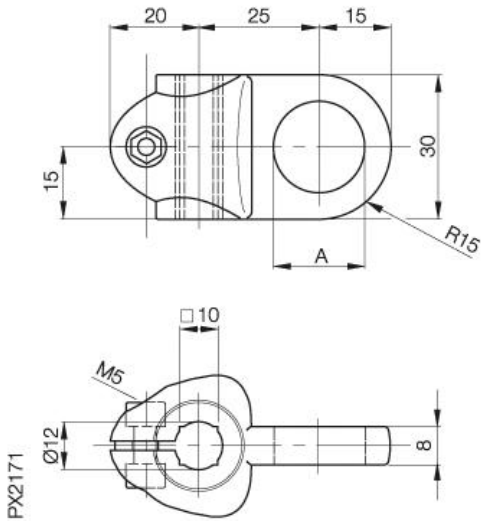

Datasheet number::

Definitions see general catalog.

If not otherwise noted, ratings according to
IEC 60947-5-2 (DIN EN60947-5-2)

Balluff GmbH
Schurwaldstrasse 9
73765 Neuhausen a.d.F.
Phone (07158) 173-0 Fax (07158) 5010

Datenblatt by CD-ROM - 04/2007

BALLUFF
sensors worldwide